

22308 E

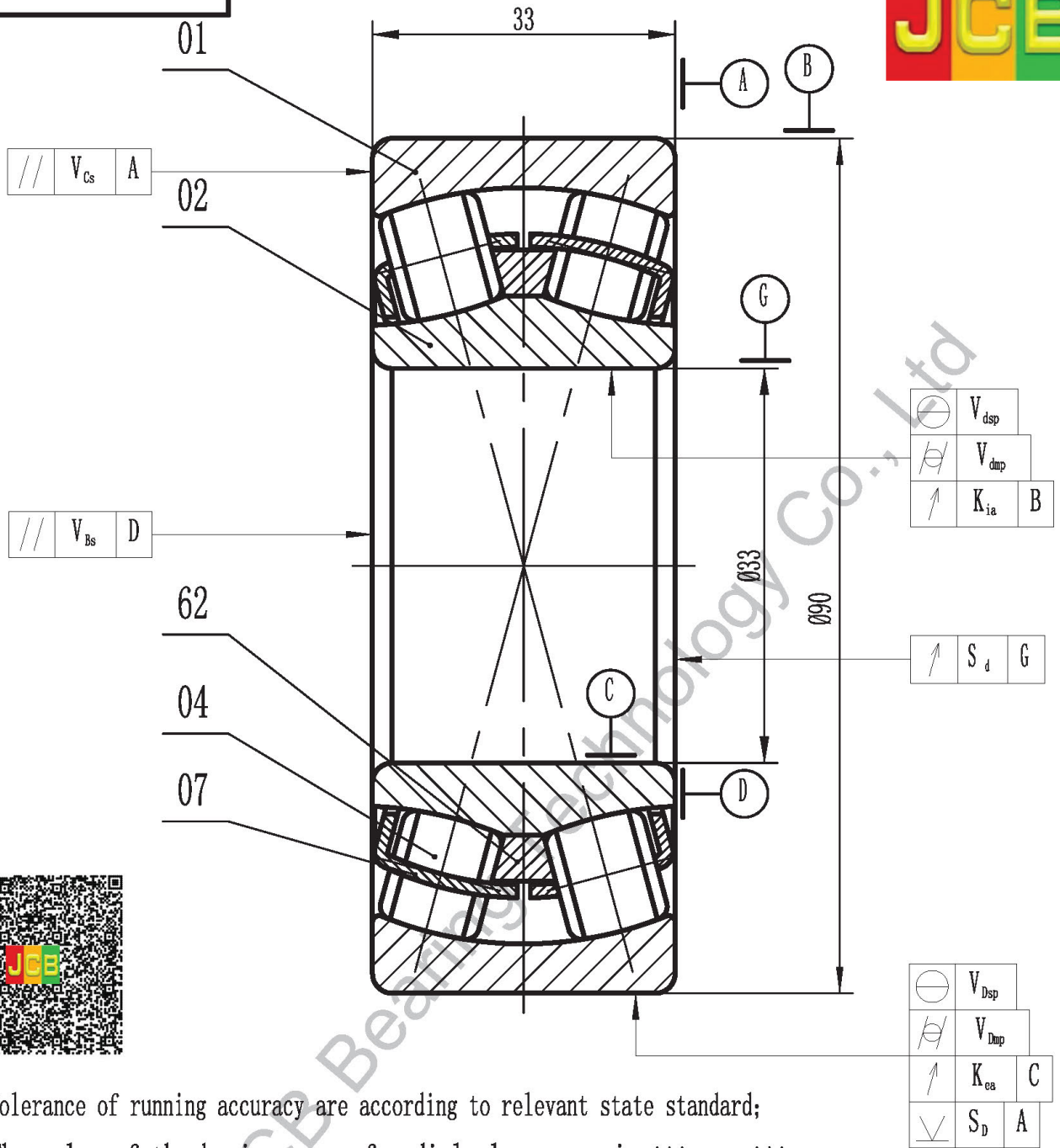

1. Tolerance of running accuracy are according to relevant state standard;
2. The value of the basic group of radial clearance:min *** max ***;
3. Rated load: Cr=**** kN Cor=**** kN.

62	Guide ring		Steel 20—GB699			
07	Cage		Steel St 52-EN 10025:1990 + A:1993			
04	Roller		Steel 100Cr6—ISO 683-17:1999			
02	Inner ring		Steel 100Cr6—ISO 683-17:1999			
01	Outer ring		Steel 100Cr6—ISO 683-17:1999			
No.	Name	Qty	Material	Unit	Total	Remark
				Weight (kg)		

Luoyang JCB Bearing Technology Co., Ltd
 Contact information
 Company Address : No. 285, Fenghua road,
 Luoyang, Henan, China.
 Postal code : 471000
 Phone : 86-379-68611678
 Fax : 86-379-68611679
 E-mail: sales@jcb-bearing.com
 Reserved E-mail:
 sales@sphericalrollerbearing.net
 Website: www.jcb-bearing.com
 www.sphericalrollerbearing.net

Spherical Roller Bearing

22308 E

		Weight(kg)	Scale
S			—
Total page 6		Page No. 1	

Luoyang JCB Bearing Technology Co., Ltd